

CertainTeed  
**Platon**  
Sub-Floor System

Makes floors over concrete...

**Warm & dry**

**Versatile**

**Comfortable,  
Odor Free  
Healthy & Dry**

Impermeable damp-proof barrier lifts the floor off damp, cold concrete and allows the concrete to breathe.

**platon**<sup>®</sup>  
KEEP IT DRY.

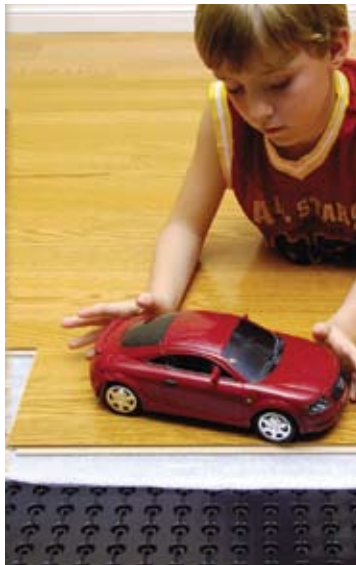

**Platon Flooring Protector**

A beautiful floor may hide an ugly reality. Even though it may look good on the surface, the reality underneath may be entirely different.

Concrete floors always contain moisture. Floor coverings laid on concrete without an adequate damp-proof barrier will be affected and damaged. The results are unpleasant odors, mold, mildew and an unhealthy internal environment. A moisture barrier that does not provide air flow may trap moisture and cause problems.

**Platon – The Solution for Flooring over concrete**

Platon is a strong, double dimpled, 24 mil HDPE membrane. By using Platon over the concrete, an impermeable vapor barrier and air gap is created. This allows the concrete to breathe while keeping the floor dry. The finished floor is isolated from the cold concrete and becomes room temperature, not slab temperature. This keeps you warm and minimizes surface condensation and musty odors.



Platon Flooring Protector gives you a new freedom of choice in floor covering materials. Carpet, vinyl, laminate or hardwood can be installed over Platon and OSB or plywood subfloor.

On fresh concrete you can install flooring as soon as you can walk on the slab. Platon can also be installed on floors with radiant heat.

If your basement is unfinished, install Platon and plywood or OSB subfloor, and frame the walls right on top of the subfloor. If the walls are damp, cover them with Platon!

**Lifts the floor off cold, damp concrete!**

- Flooring roll size 44 1/2" x 49' (covers 185 sq.ft.) providing a 1/4" airspace. Other sizes available.
- Load bearing capacity 6,000 lb/sq.ft.
- Dual purpose! Also used as exterior foundation leakage protection.

**buildingresponsibly**<sup>™</sup>

*CertainTeed respects the environment through the responsible development of sustainable building products and systems.*

Platon is a registered mark of Isola A/S.

**ASK ABOUT OUR OTHER CERTAINTEED PRODUCTS AND SYSTEMS:**  
**EXTERIOR:** ROOFING • SIDING • WINDOWS • FENCE • RAILING • TRIM  
DECKING • FOUNDATIONS • PIPE  
**INTERIOR:** INSULATION • GYPSUM • CEILINGS

CertainTeed Corporation  
P.O. Box 860  
Valley Forge, PA 19482

Professional: 800-233-8990  
Consumer: 800-782-8777  
[www.certainteed.com](http://www.certainteed.com)

**Now the exclusive USA supplier!**

**CertainTeed**  
Quality made certain. Satisfaction guaranteed.<sup>™</sup>

**CertainTeed**  
Quality made certain. Satisfaction guaranteed.<sup>™</sup>

**CertainTeed**

# Easy to install

# Do it yourself

# Feel the difference

## Floating Floors

Laminate flooring and its underpad may be placed directly over Platon as a “floating floor”. For very high point loads, such as slate billiard tables, the laminate should be installed over a minimum 7/16" “secured subfloor.”

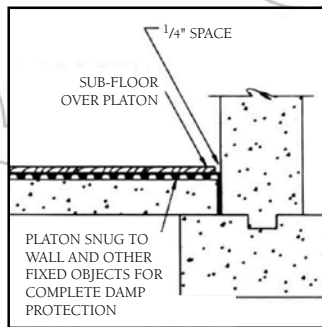

## Secured Subfloors

For other floor finishes, plywood or OSB sheets (7/16" minimum thickness) are laid as a subfloor over the Platon and fastened to the concrete floor – 24" grid spacing.

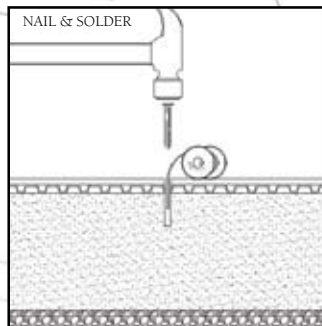

**Hint:** Fasten with concrete screws or drill a hole the same diameter as a fluted masonry nail (3/16" x 2 1/4" deep), insert wire plumbers solder and drive a 2" masonry nail in beside the solder.

1. Remove existing floor coverings. Ensure that concrete is clear of debris. Level low areas with floor levelling compound if required.

2. Roll out the first strip of Platon, dimples toward the floor, flat tab away from the wall and cut to length. Cut off the flat tab. “Reverse roll” the Platon if it curls excessively.

3. Unroll the next section with the flat tab overlapping the first section and cut to length. Apply Butyl Rubber caulk or foam panel adhesive between the flat tab and adjacent section or use “housewrap” tape to seal the overlap. At “end of roll” joints, mesh four rows of dimples and caulk or tape.

4. Cover the Platon with either butt-edge or tongue and groove (T&G) plywood or OSB sheets (7/16" minimum). Fasten through the sub-floor and Platon 1" into the concrete in a 24" grid and/or where there is vertical movement. The 4' joints between adjacent 4x8 sheets should be staggered. Leave 1/4" clearance around the perimeter of the sub-floor to allow for expansion. Non load-bearing walls may now be framed on the sub-floor.

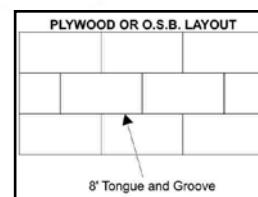
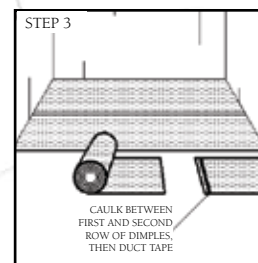
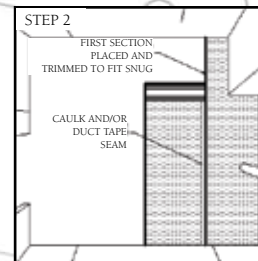
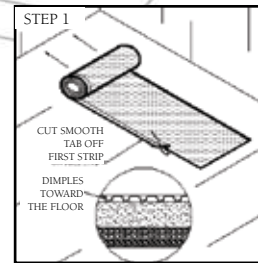

**Install your choice of flooring**, following the floor manufacturer’s installation recommendations. Additional instructions specific to Platon subfloor installations are as follows:

**Vinyl Floor:** Glue and staple 1/4" underlay (as recommended by the flooring manufacturer) over the second subfloor. Stagger the joints between the underlay and the subfloor.

**Hardwood:** If the flooring is to be nailed down, use 3/4" OSB and short nails or two layers of subflooring (totalling 1" or more) so as not to puncture the Platon.

**Laminate flooring:** For a “floating floor”, laminate flooring with the recommended underpad may be installed directly over Platon. **The concrete floor must be level as per laminate manufacturers specifications.** Landscape fabric (optional) may be placed over the concrete before installing Platon to improve sound characteristics. For very high point loads such as slate billiard tables, the laminate should be installed over a minimum 7/16" OSB load spreading sheet.

**Carpets:** Install over a minimum 7/16" subfloor fastened in a 24" grid pattern.

*All information provided herein is intended to be used as a guide only. No recommendations are to be interpreted as superseding or replacing any installation recommendations of the flooring manufacturer. No warranty on the performance of the floor covering is given or implied.*